

### 1 INTRODUCTION

GNS electronics, developer and manufacturer of module solutions for over 20 years, presents the new GNS5892R ADS-B module for 1090MHz "Virtual Radar" monitoring.

The high dynamic signal processing circuit allows to receive ADS-B reception from near field to wide range simultaneously.

The module integrates a sensitive RF frontend , signal processing , a high speed data decoder and an output uart that can be easily connected to a host processor.

GNS5892R features a special ultra fast level adaption circuit that eliminates the so called "doughnut effect".

#### Features

- ADS-B all-in-one module
- max. sensitivity -87dBm
- no "doughnut effect"
- Small outline 26x15x3.3mm
- Low power consumption : 42mA
- Frame decode indicator output
- Easy to mount stamp hole PCB design
- Evaluation Board with USB bridge available

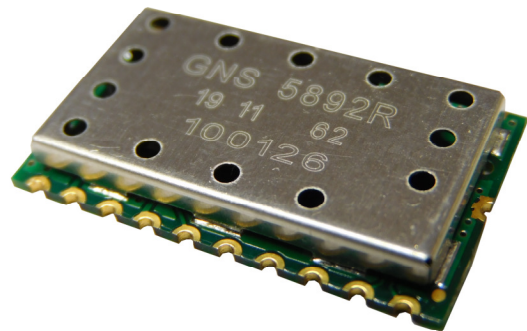

#### Applications

- Aviation safety
  - "Virtual Radar" for small aircrafts
  - Add- on data for flight navigation
- Ground equipment
  - Virtual Radar for ground based equipment
  - Hand held "plane spotting" devices
  - Data loggers for internet based online Virtual Radar systems

### 2 INDEX

<b>1</b>	<b>INTRODUCTION</b>	<b>1</b>
<b>2</b>	<b>INDEX</b>	<b>2</b>
<b>3</b>	<b>BLOCK DIAGRAM</b>	<b>3</b>
<b>4</b>	<b>TYPICAL APPLICATION BLOCK DIAGRAM</b>	<b>3</b>
<b>5</b>	<b>DETAILED DESCRIPTION</b>	<b>4</b>
5.1	UART Interface details	5
5.2	Power supply	6
5.3	Reset input	6
5.4	Frame available output	6
5.5	RF input (RFin)	6
5.6	ADS-B antenna	6
<b>6</b>	<b>ELECTRICAL SPECIFICATION</b>	<b>7</b>
6.1	Absolute Maximum Ratings	7
6.2	Recommended Operating Conditions	7
6.3	Characteristics	7
6.4	RF input characteristics	7
<b>7</b>	<b>DEVICE PINOUT DIAGRAM</b>	<b>8</b>
<b>8</b>	<b>ADS-B DATA</b>	<b>9</b>
<b>9</b>	<b>COMMAND INTERFACE</b>	<b>10</b>
9.1	GNS5892R commands	10
9.2	GNS5892R command reply examples	11
9.3	ADS-B data frame reception	11
<b>10</b>	<b>PHYSICAL DIMENSIONS</b>	<b>14</b>
<b>11</b>	<b>RECOMMENDED PAD LAYOUT</b>	<b>15</b>
<b>12</b>	<b>MATERIAL INFORMATION</b>	<b>15</b>
12.1	Shield Material Information	15
<b>13</b>	<b>RECOMMENDED SOLDERING REFLOW PROFILE</b>	<b>16</b>
<b>14</b>	<b>TAPE INFORMATION</b>	<b>17</b>
<b>15</b>	<b>REEL INFORMATION</b>	<b>18</b>
<b>16</b>	<b>ORDERING INFORMATION</b>	<b>18</b>
<b>17</b>	<b>ENVIRONMENTAL INFORMATION</b>	<b>19</b>
<b>18</b>	<b>MOISTURE SENSITIVITY</b>	<b>19</b>
<b>19</b>	<b>DOCUMENT REVISION HISTORY</b>	<b>19</b>
<b>20</b>	<b>DISCLAIMER</b>	<b>20</b>

### 3 BLOCK DIAGRAM

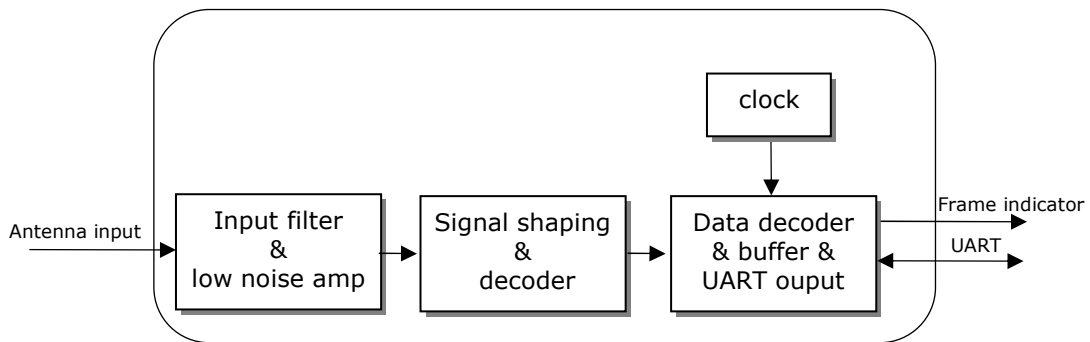

### 4 TYPICAL APPLICATION BLOCK DIAGRAM

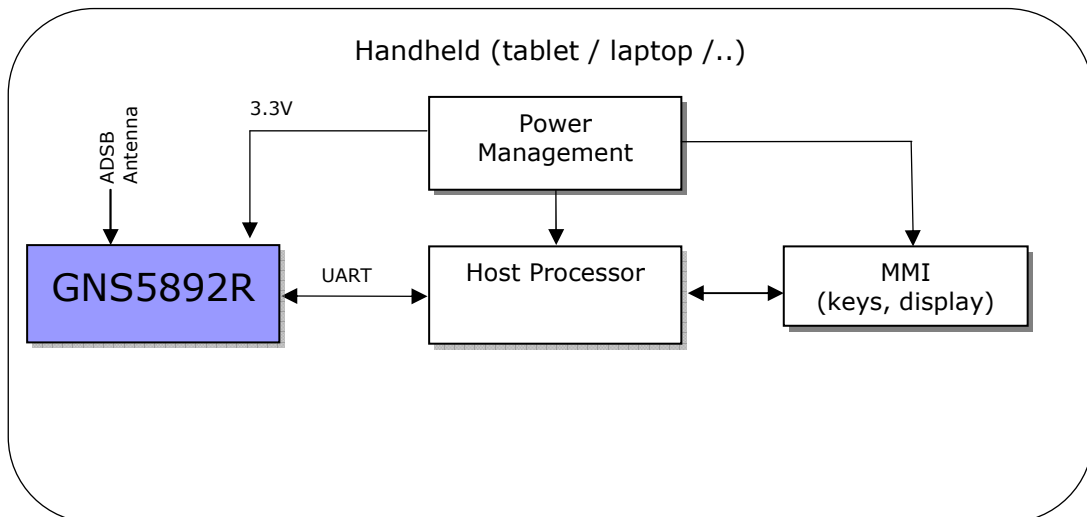

### 5 DETAILED DESCRIPTION

GNS5892R is a high performance receiver for ADS-B.

Due to high input sensitivity it can work directly with a passive antenna.

The improved RF architecture and outstanding decoder circuit together with the enhanced firmware provides maximum performance at minimum space and power requirements.

GNS5892R features a special ultra fast level adaption circuit that overcomes the so called "doughnut effect".

This input stage allows to receive very strong "near" and and very weak "far" signals at the same time without losses.

GNS5892R includes a complete ADS-B receiver. An appropriate power supply of 3.3V and a special antenna must be connected for operation.

- The signal picked from air is filtered and decoded without any host processing requirements.
- ADS-B –S data is provided at the serial UART port with a baudrate of 921kbaud. An appropriate host system with application must read and interpret the data and present them through the UI.
- No external clocks are required.

### 5.1 UART Interface details

GNS5892R must be connected to the host system by a UART Interface.

- The UART interface is used to send ADS-B text messages and receive control messages.
- The default baud rate is 921600 baud, this baudrate is needed to transport the data without any data losses.
- For safe communication, implementing hardware handshake via RTS and CTS is recommended.
- I/O levels are 3.3V (see electrical data)

GPS UART Default Settings	
Parameter	Value
Baud rate	921,600
Data length	8 bits
Stop bit	1
Parity	None
Handshake	hardware

The idle state of the UART lines is positive voltage. To interface a standard RS232 UART (e.g. a PC serial interface), please add an inverting level shifter. To interface processors that have a different interfacing voltage level, level shifters are required.

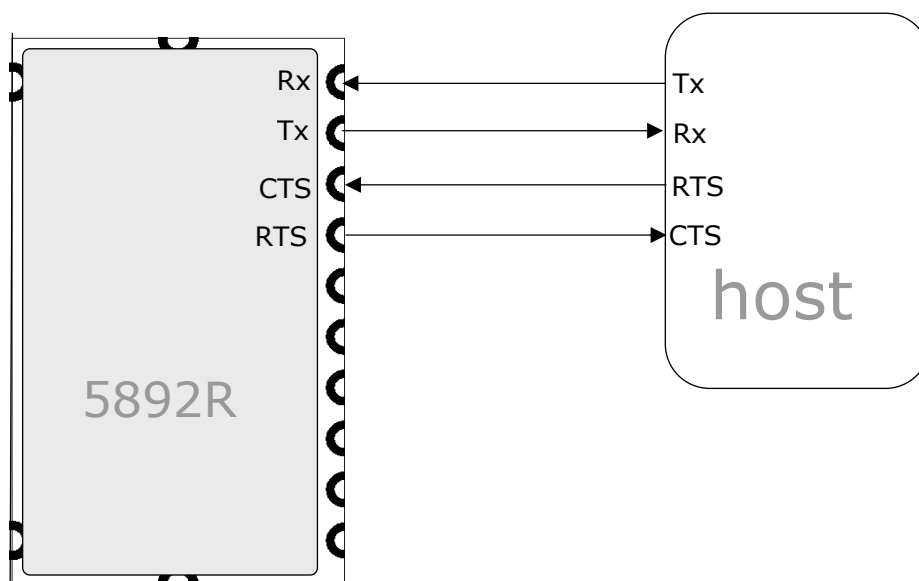

### 5.2 Power supply

GNS5892R needs a single power supply of 3.1..3.5V. The current consumption is ~40mA at full operation. The power supply should be well filtered by placing a minim.10uF tantalum in parallel with a 100nF ceramic capacitor as near to the Vdd pin (4) as possible.

### 5.3 Reset input

The reset input is optional. Drawing this pin to low will reset the internal microprocessor. Reset can be left open for the most applications.

### 5.4 Frame available output

The frame available signal is used to indicate frames being successfully decoded. The pin will be set to high for 1ms whenever a frame comes in. The signal can be used by a host processor or may drive a LED to provide a visual feedback of the incoming data frames.

### 5.5 RF input (RFIn)

The RF input pin has a nominal impedance of 50 Ohms. Please keep tracks from module to antenna connector as short as possible. If more than a few millimetres track length is needed, the tracks must be impedance controlled (e.g. microstrip line). Please remember that the signal frequency is over 1 GHz. For connecting the antenna, a SMA or MCX connector should be used. On request, GNS can offer RF-support regarding PCB design.

### 5.6 ADS-B antenna

Depending on the application, a small rod antenna of just 20cm length can be used. This will provide a range of up to 200km around your location. However, using a high gain antenna will offer much more range and continuous tracking. Both types of antenna are available from GNS. For antenna installation, it's important to know that ADS-B signals will spread linearly only. Any obstacles like buildings, mountains or woods will mute or even totally block ADS-B signals. Antenna should be mounted to have an unobstructed "view" in all directions from a raised location.

**ATTENTION: Risk of fire and injury ! For any raised mounted antenna constructions like roof antennas or aerial masts, it's mandatory to follow the rules for lightning protection. In case of doubt please consult a professional specialist**

## 6 ELECTRICAL SPECIFICATION

### 6.1 Absolute Maximum Ratings

Parameter	Value	Unit
Supply voltage range: $V_{dd}$	-0.5 to 3.5	V
DC Input voltage to antenna input <sup>1</sup>	-0.5 to $V_{dd}$	V
Input voltage to all other pins	-0.5 to $V_{dd}$	V
Operating ambient temperature range	-20 to +70	°C
Storage temperature range	-40 to +85	°C

### 6.2 Recommended Operating Conditions

Parameter	Min	Typ	Max	Unit	Note
$V_{dd}$	3.1	3.3	3.5	V	Power-supply voltage
High level output voltage $V_{OH}$	$0.8 * V_{dd}$		$V_{dd}$	V	IOU <sub>T</sub> = 4 mA, pins 5,7,9
Low level output voltage $V_{OL}$	0		$0.2 * V_{DD}$	V	IOU <sub>T</sub> = 4 mA, pins 5,7,9
High-level input voltage $V_{IH}$	$0.65x V_{dd}$		$V_{dd}$	V	pins 6,8,10
Low-level input voltage $V_{IL}$	0		$0.35x V_{dd}$	V	pins 6,8,10
Operating temperature	-20		70	°C	Full specified performance

### 6.3 Characteristics

Parameter	Min	Typ	Max	Unit	Note
general					
Frequency		1090		MHz	ADS-B – mode S
Output data frequency		921		kBit/sec	Uart baudrate
UART baud deviation			0.1	%	
sensitivity		-87		dBm	Frame detection level
Power consumption					
Current full operation		42		mA	
Supply voltage	3.1	3.3	3.5	V	

### 6.4 RF input characteristics

Parameter	Min	Typ	Max	Unit	Note
Input impedance		50		Ω	
Maximum input level	0			dBm	before destruction
Input return loss		-11		dB	

### 7 DEVICE PINOUT DIAGRAM

TOP VIEW

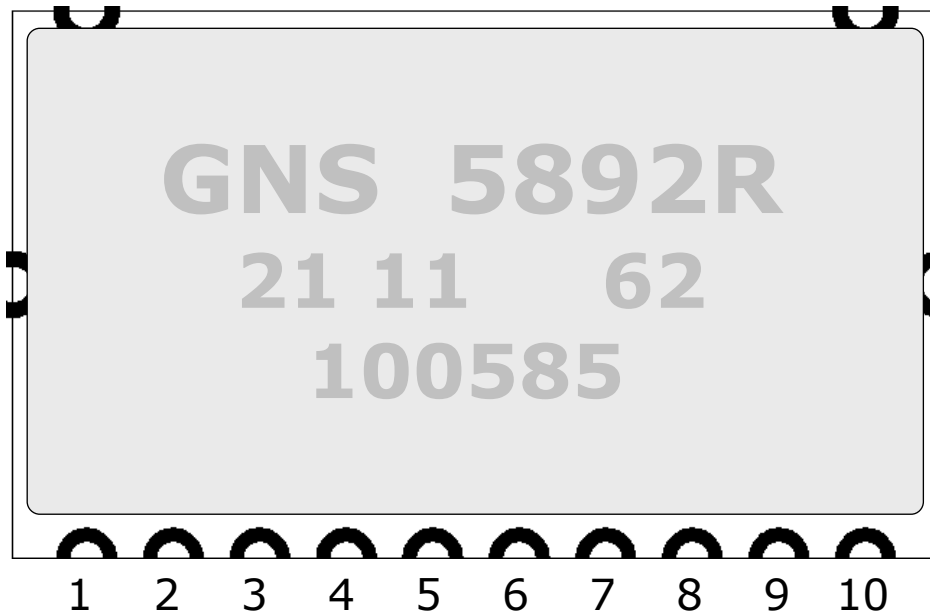

NO	NAME	TYPE	DESCRIPTION
1	RF Gnd	G	RF Ground
2	RF in	Ana	RF input
3	Gnd	G	Supply Ground
4	Vdd	P	Supply voltage 3.3V
5	F_ind	O	Frame indicator
6	RESET	I	Reset input
7	RTS	O	UART Ready to Send
8	CTS	I	UART Clear to Send
9	UART Tx	O	UART Serial data out
10	UART Rx	I	UART Serial data in

G=Ground; Ana = analogue; P=power supply; O= dig. Output; I=digital Input



## 8 ADS-B DATA

The output data format is ASCII ADS-B text format and compatible with many common software applications.

There are 25 possible types that will be all available, but for Virtual Radar applications, type 11 and 17&18 (extended squitter) are most important.

The following table shows all types in a short form. For further information, please refer to ADS-B specifications, for example the publications from ICAO (International Civil Aviation Organization).

Mode-S reply available sentences								
DF	Type						content	
00000	VS:1	7	RI:4	2	AC:13	AP:24	Short air-air surveillance (ACAS)	
00001	27 or 83						P:24	Reserved
00010	27 or 83						P:24	Reserved
00011	27 or 83						P:24	Reserved
00100	FS:3	DR:5	UM:6	AC:13	AP:24	AP:24	Surveillance, altitude reply	
00101	FS:3	DR:5	UM:6	ID:13	AP:24	AP:24	Surveillance, identify reply	
00110	27 or 83						P:24	Reserved
00111	27 or 83						P:24	Reserved
01000	27 or 83						P:24	Reserved
01001	27 or 83						P:24	Reserved
01010	27 or 83						P:24	Reserved
<b>01011</b>	<b>CA:3</b>	<b>AA:24</b>		<b>PI:24</b>		<b>All-call reply</b>		
01100	27 or 83						P:24	Reserved
01101	27 or 83						P:24	Reserved
01110	27 or 83						P:24	Reserved
01111	27 or 83						P:24	Reserved
10000	VS:1	7	RI:4	2	AC:13	MV:56	AP:24	Long air-air surveillance (ACAS)
<b>10001</b>	<b>CA:3</b>	<b>AA:24</b>		<b>ME:56</b>		<b>PI:24</b>	<b>Extended squitter</b>	
<b>10010</b>	<b>CF:3</b>	<b>AA:24</b>		<b>ME:56</b>		<b>PI:24</b>	<b>Extended squitter/non transponder</b>	
10011	AF:3	104						Military extended squitter
10100	FS:3	DR:5	UM:6	AC:13	MB:56	AP:24	Comm-B, altitude reply	
10101	FS:3	DR:5	UM:6	ID:13	MB:56	AP:24	Comm-B, identify reply	
10110	27 or 83						P:24	Reserved for military use
10111	27 or 83						P:24	Reserved
11xxx	1	KE:1	ND:4	MD:80	AP:24	AP:24	Comm-D (ELM)	

AA:Address announced ; AC:Altitude code ; AF:Application field ; AP:Address/parity ; AQ:Acquisition ; CA:Capability ; CC:Cross-link capability ; CF:Control field ; CL:Code label ; DF:Downlink format ; DI:Designator identification ; DR:Downlink request ; DS:Data selector ; ELM:Extended length message ; FS:Flight status ; IC:Interrogator code ; ID:Identità ; KE:Control, ELM ; MA:Message, Comm-A ; MB:Message, Comm-B ; MC:Message, Comm-C ; MD:Message, Comm-D ; ME:Message, extended squitter ; MU:Message, ACAS ; MV:Message, ACAS ; NC:Number of C-segment ; ND:Number of D-segment ; PC:Protocol ; PI:Parity/interrogator identifier ; PR:Probability of reply ; RC:Reply control ; RI:Reply information ; RL:Reply length ; RR:Reply request ; SD:Special designator ; UF:Uplink format ; UM:Utility message ; VS:Vertical status

## 9 COMMAND INTERFACE

### Write Commands

- Commands consist always of minimum 2 ASCII characters
- 2 ASCII characters compose 1 binary command or parameter value
- Command and parameter values as well as consecutive parameter values are separated by a delimiter character '-'
- Every command starts with '#'
- Every command is finished by 'Carriage Return' (0x0D)

9.1 GNS5892R commands				
command	value	parameter	example	description
Reset Device	FF	none	#FF<CR>	HW-reset of GNS5892R is performed.
Read FW version	00	none	#00<CR>	Queries f/w version
Set ADS-B mode	49	mode#	#49-02<CR>	mode 02 (output ALL DF – data) See note 1
Set Comparator Offset	39	xx-xx-value	#39-00-00-6E	Parameters #1 & #2 are ignored. Value must be in [10 .. 200] range.Default value is 100 [0x64]. See note 2.

notes	
1	GNS5892R can operate in 4 active modes and 1 inactive mode (Mode 0). Mode 0: (mode# = 00) stop data output. Mode 2: (mode# = 02) output all DF – Data. Mode 3: (mode# = 03) output DF17 / DF18 / DF19 – Data only. Mode 2+: (mode# = 82) output all DF – Data with additional Signal Strength Indicator. Mode 3+: (mode# = 83) output DF17 / DF18 / DF19 – Data only with additional Signal Strength Indicator.
2	The GNS5892R signal decoder uses an internal comparator to compare the signal level with an internal dynamic reference voltage level. This reference voltage level can be adjusted within narrow limits from its default value (100) to increase the decoders sensitivity.

**Command Replies**

- Replies consist always of 16 binary values, each value formed of 2 ASCII characters
- Consecutive values are separated by a delimiter character '-'
- Every reply starts with '#'
- Every reply is finished by 'Line Feed + Carriage Return' (0x0A 0x0D)
- 1<sup>st</sup> and following reply values represent the echo of the previous command. Unused values are padded with '00'
- In case of command error the 1<sup>st</sup> value is 'FF'
- In case of parameter error the 2<sup>nd</sup> value is 'FF'

9.2 GNS5892R command reply examples		
prev. Command	Reply	Note
#FF<CR>	no reply	Device performs a cold start
#49-02<CR>	#49-02-00-00-00-00-00-00-00-00-00-00-00-00-00-00<LF CR>	Command accepted
#39-00-00-6E<CR>	#39-00-00-6E-00-00-00-00-00-00-00-00-00-00-00-00-00<LF CR>	Comparator offset is set to 110. (0x6e).
#00<CR>	#00-00-80-04-ww-yy-fw-00-00-00-00-00-00-00-00-00-00<LF CR>	ww – week (BCD coded) yy – year (BCD coded) fw – firmware version
#55<CR>	#FF-00-00-00-00-00-00-00-00-00-00-00-00-00-00-00<LF CR>	Unknown command
#49-14<CR>	#49-FF-00-00-00-00-00-00-00-00-00-00-00-00-00-00<LF CR>	Wrong parameter

**9.3 ADS-B data frame reception**

**9.3.1.1 mode 2 (reception of all DF-Data)**

In case of ADS-B mode 2 (reception of all DF-Data) the 56bit or 112bit raw data frames are output as 14 bytes ASCII frames , or 7 bytes ASCII frames, MSB first.  
Every ASCII frame begins with an '\*' and is finished by ';' + <CR><LF>.

Example:

\*02E19838575F0A;

...  
\*8D4B1621994420C18804887668F9;  
\*02E1991058EF31;  
\*20000CB10D89FB;  
\*20001196553C25;  
\*02E198BFAF8676;  
\*02C18CB14E2D98;  
\*02E198BFAF8676;  
\*200015301CB296;  
\*20000F971E4582;  
\*200015B3EF4577;  
\*583E1BDABC2735;  
\*280008006C738F;  
\*5D3C5961BAAB6C;  
\*8D4CA27A608145305B0B09EAD8B5;

Remark:

\*8D.... is DF18 **Extended squitter**  
\*5D.... is DF11 **All-call reply**



### 9.3.1.2 mode 2+ (recept. of all DF-Data with add. Signal Strenght Indicator)

In case of ADS-B mode 2+ (reception of all DF-Data with additional Signal Strenght Indicator) the 56bit or 112bit raw data frames are output as 15 bytes ASCII frames , or 8 bytes ASCII frames, MSB first.

Every ASCII frame begins with an '+' and is finished by ';' + <CR><LF>.

The first byte following the '+' is the signal strength indicator of the current ADS-B frame.

The following bytes represent the received ADS-B data.

Example:

```

...
+1B5D3DDDD1707EA1;
+1AA800023AC4600030A80000FB50EB;
+1A80E1969158B51233C9445A63D2C7;
+1CA00002340008D70AFFC800EB0AEC;
+1BA00002340008D70AFFC800EB0AEC;
+1A80E1969158B51233C544583A3DD0;
+1B5D3DDDD1707EA1;
+1A5DC03ABCB09F16;
+1B020502344DA06C;
+1BA0000234200903F2CA0820AD4526;
+19A0001691FA81C100000000BBB0E0;
+1A200016917CBBF2;
+1A200016917CBBF2;
+19A0001691FA81C100000000BBB0E0;
+1A02E61691A25E5B;
+1A5DC03ABCB09F16;
+1902E196917A63B8;
+185D3CCD4B9AF88F;
+1B20000234A0B9D0;
+1A20000234A0B9D0;
+1AA0001691C4600030A80000EBA589;
+1A8DC03ABC58B51233A9445A329207;
+1AA800023AC4600030A80000FB50EB;
+1AA0001691AA4A1331201400F416FB;
+1A8DC03ABC9901939CA00706079C17;
+195DC03ABCB09F1C;
...

```

### Important note

The Signal Strength Indicator preceded by the data is only an indicator of the field strength of the received frame and not a measured value from which the distance to the transmitter can be derived. The range of the value is approximately between 0x18(far distance signals) and 0x2d (near distance signals).

### 10 PHYSICAL DIMENSIONS

TOP VIEW

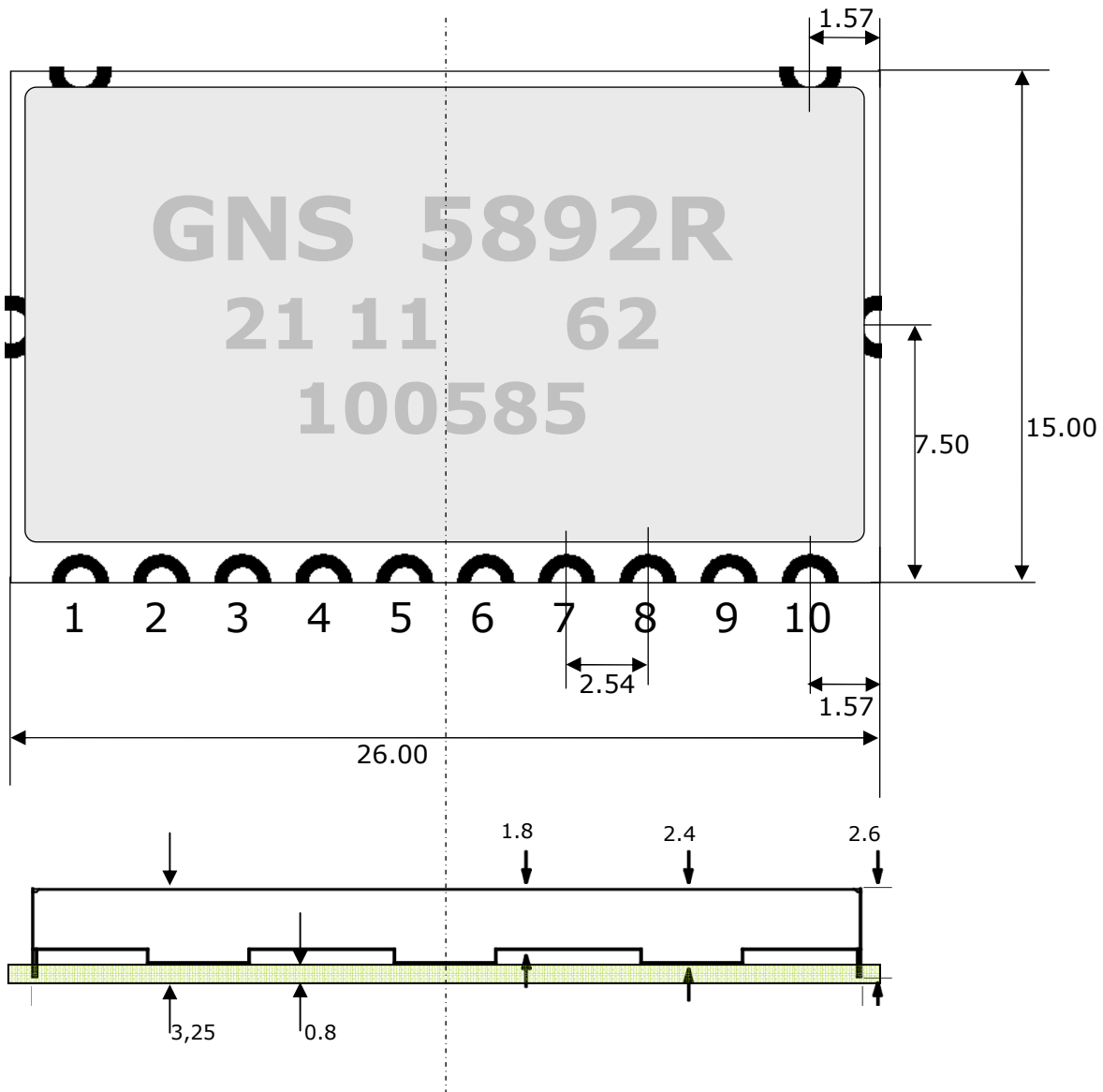

all units in mm

tolerance +/- 0.1 mm

### 11 RECOMMENDED PAD LAYOUT

TOP VIEW

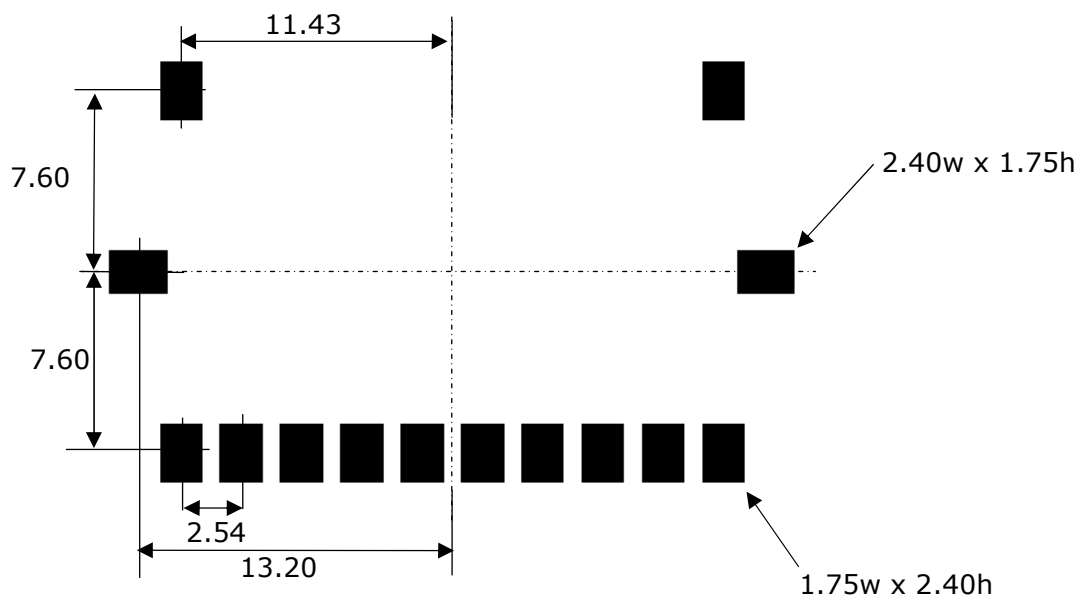

all units in mm

### 12 MATERIAL INFORMATION

#### 12.1 Shield Material Information

"German Silver " , CuNi18Zn27

Cu: 53.5..56.5%

Ni : 16.5..19.5%

Zn : 24..30%

thickness :0.2mm

### 13 RECOMMENDED SOLDERING REFLOW PROFILE

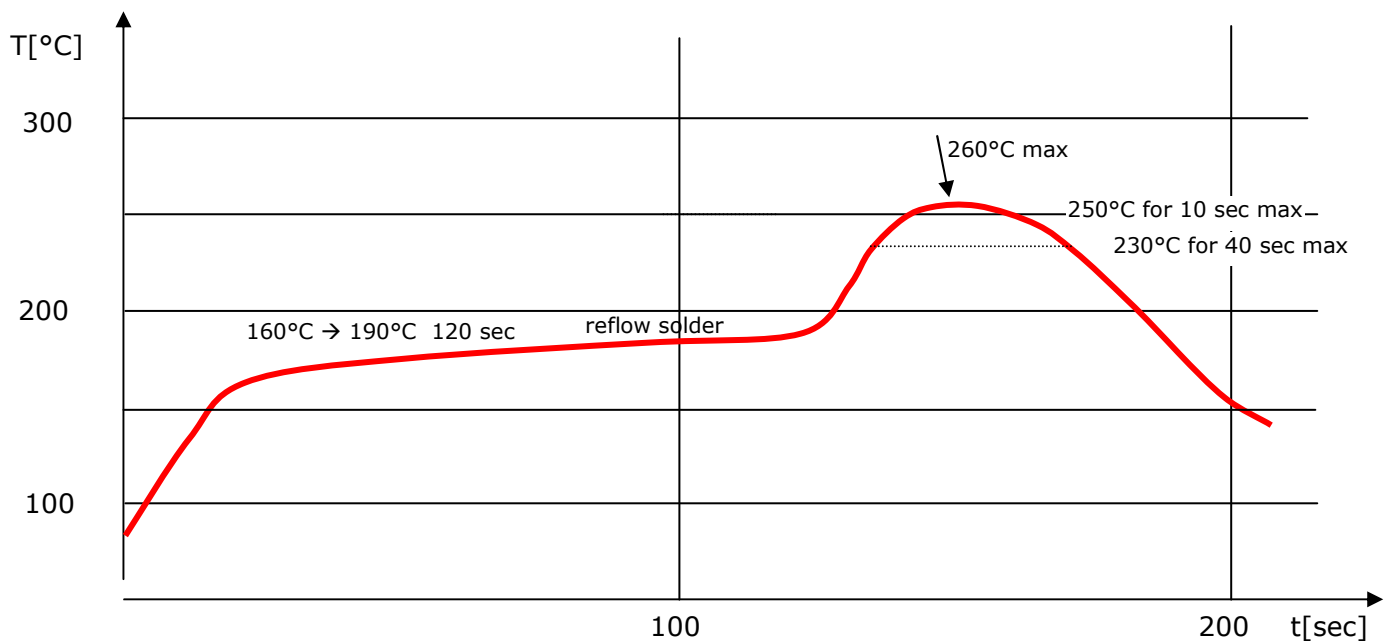

#### Notes:

1. GNS5892R should be soldered in upright soldering position. In case of head-over soldering, please prevent shielding / GNS5892R Module from falling down.
2. Do never exceed maximum peak temperature
3. Reflow cycles allowed : 1 time
4. Do not solder with Pb-Sn or other solder containing lead (Pb)
5. This device is not applicable for flow solder processing
6. This device is not applicable for solder iron process



### 14 TAPE INFORMATION

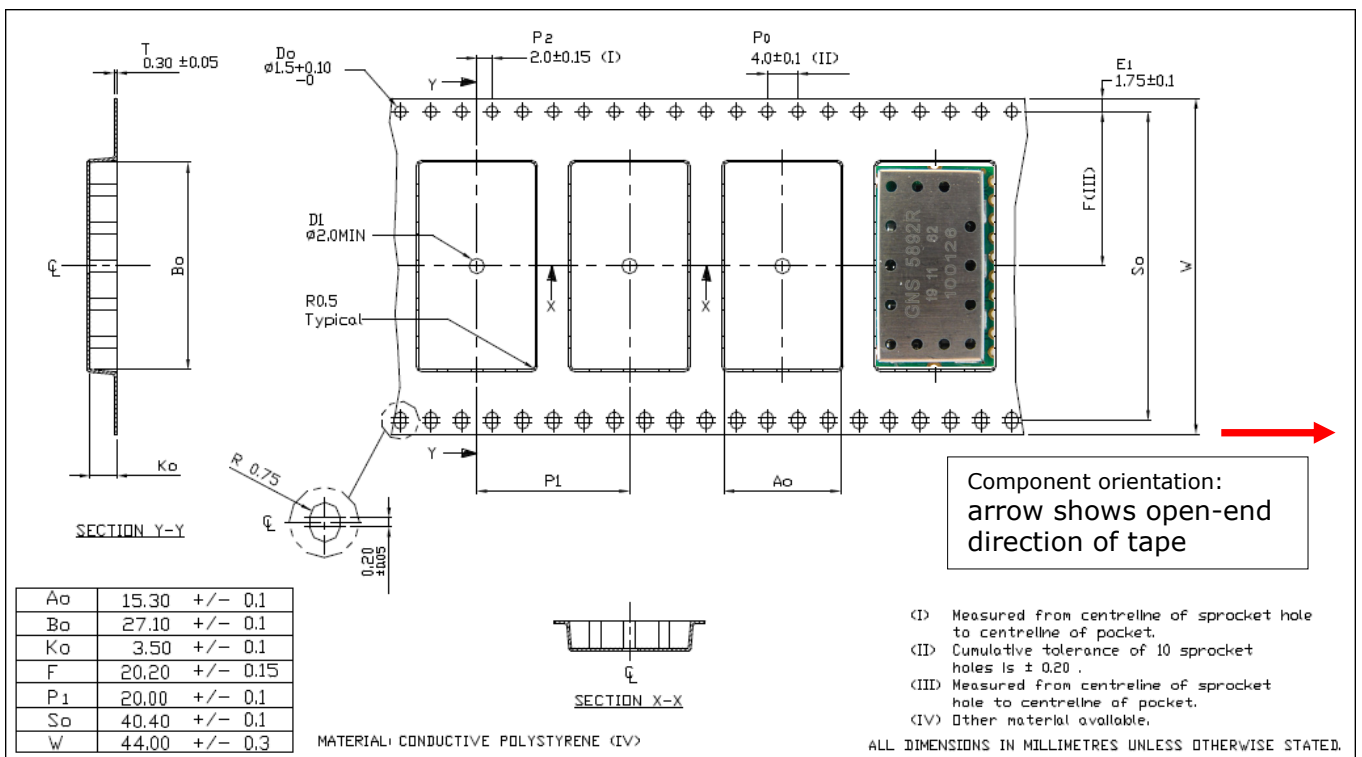

### 15 REEL INFORMATION

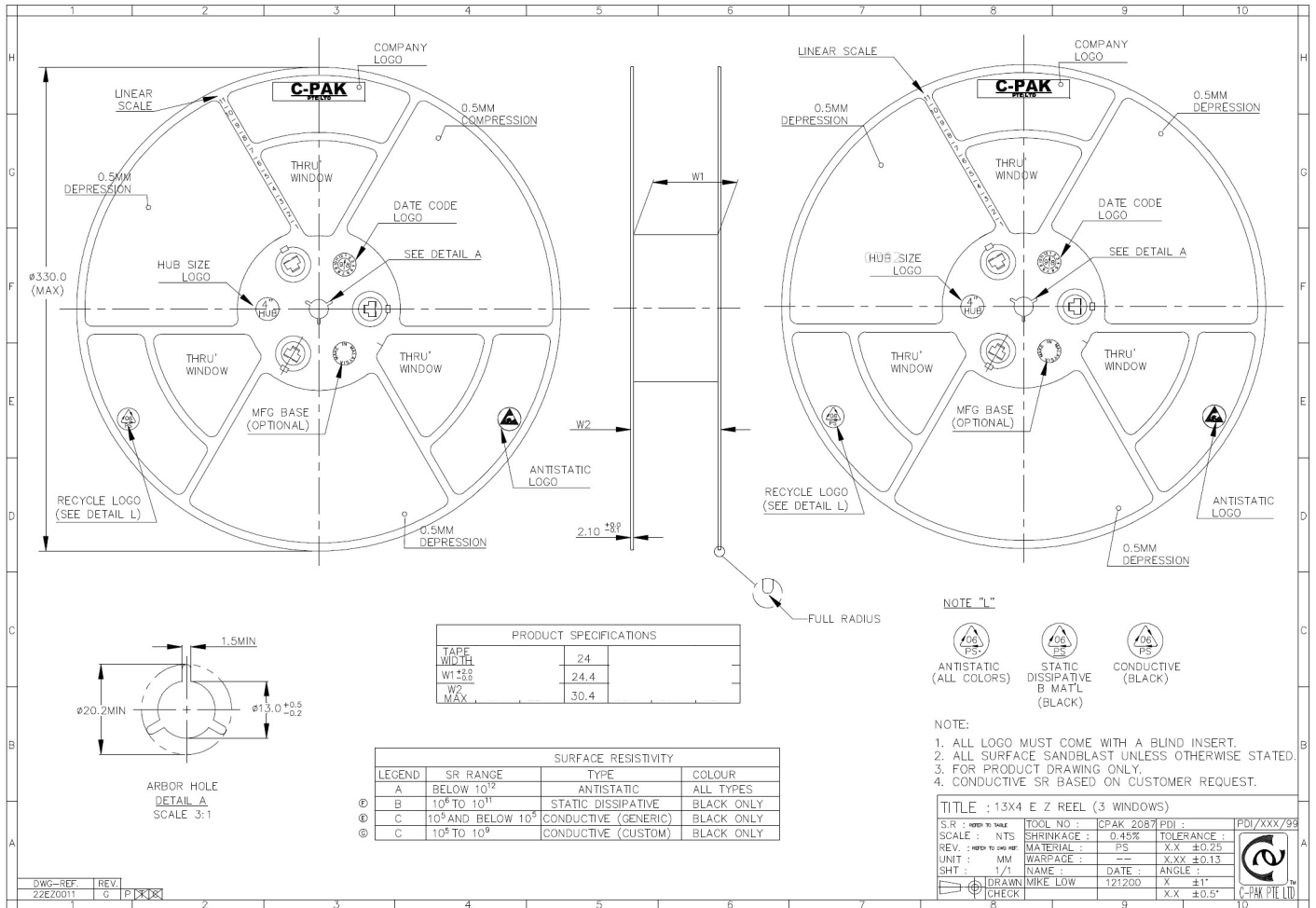

no. of devices : 500 pcs / reel

### 16 ORDERING INFORMATION

Ordering information			
Type	Part#	Laser marking	Description
GNS 5892R ADS-B module	4037735104784	GNS 5892R <yy cw> <FWversion > <serial#>	ADS-B serial module

### 17 ENVIRONMENTAL INFORMATION

This product is free of environmental hazardous substances and complies to “RoHS II” 2011/95/EU (Recast 2002/95/EG) and further applicable Delegated Directive 2015/863/EU. (“RoHS III”).

### 18 MOISTURE SENSITIVITY

Shelf life	Unlimited
Storage conditions	≤30°C/85%RH
Moisture Sensitivity Level (MSL)	3
Possible prebake recommendations	None

### 19 DOCUMENT REVISION HISTORY

V0.1	Oct 4 2012	P.Skaliks	initial
V0.2	Oct 7 2012	M.Heinzel	ADS-B Data table completed
V0.3	Oct 26 2012	M.Reiff	Return loss value added, laser marking changed,
V0.4	Dec 6 2012	M.Heinzel	
V0.5	Feb 6 2014	M.Reiff	Recommended Pad Layout corrected
V0.6	Jan 29 2018	O.Diegel	Canging Tape information, MSL Level and general review Module dimension
V0.7	Sep 19 2018	O.Diegel	laser marking changed and adapt the Module dimensions
V0.8	Jan 31 2019	O.Diegel	changed Module dimension, and Reel information
V.09	Mar 12 2019	M.Heinzel	Renaming of the module from GNS5892 to GNS5892R. Additional operating mode with output of an RSSI indicator to each received ADS-B frame.
V.10	May 28 2021	M.Heinzel	Correction of the lower operating voltage value to 3.1V.

### 20 DISCLAIMER

THE USE OF THE DATA RECEIVED WITH GNS 5892R MODULE IS STRICTLY LIMITED TO PERSONAL ENTHUSIAST ACTIVITIES (I.E. FOR ENTERTAINMENT PURPOSES), WHICH SPECIFICALLY EXCLUDE ANY ACTIVITIES THAT MIGHT ENDANGER YOURSELF OR THE LIVES OF OTHERS. UNDER NO CIRCUMSTANCES, GNS WILL BE HELD RESPONSIBLE FOR INCIDENTS RESULTING FROM THE USE AND/OR INTERPRETATION OF THE DATA RECEIVED.

THE INFORMATION IN THIS DOCUMENTATION DOES NOT FORM ANY QUOTATION OR CONTRACT. TECHNICAL DATA ARE DUE TO BE CHANGED WITHOUT NOTICE.

NO LIABILITY WILL BE ACCEPTED BY THE PUBLISHER FOR ANY CONSEQUENCE OF THIS DOCUMENT'S USE.

REPRODUCTION IN WHOLE OR IN PART IS PROHIBITED WITHOUT THE PRIOR WRITTEN CONSENT OF THE COPYRIGHT OWNER

© GNS - ELECTRONICS GMBH 2021

THE INFORMATION IN THIS DOCUMENTATION DOES NOT FORM ANY QUOTATION OR CONTRACT. TECHNICAL DATA ARE DUE TO BE CHANGED WITHOUT NOTICE.

NO LIABILITY WILL BE ACCEPTED BY THE PUBLISHER FOR ANY CONSEQUENCE OF THIS DOCUMENT'S USE.

REPRODUCTION IN WHOLE OR IN PART IS PROHIBITED WITHOUT THE PRIOR WRITTEN CONSENT OF THE COPYRIGHT OWNER